



I.AM

Specification Guide

I.AM

I.AM is a totally flexible and versatile table base that provides a complete family of product options for the commercial environment.

I.AM

Round/Square

6 – 10



Meeting Tables

11 – 13



Multi-Leg

14 – 15

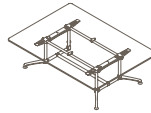

Folding

16

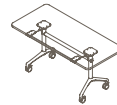

Features

17 – 18

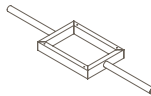

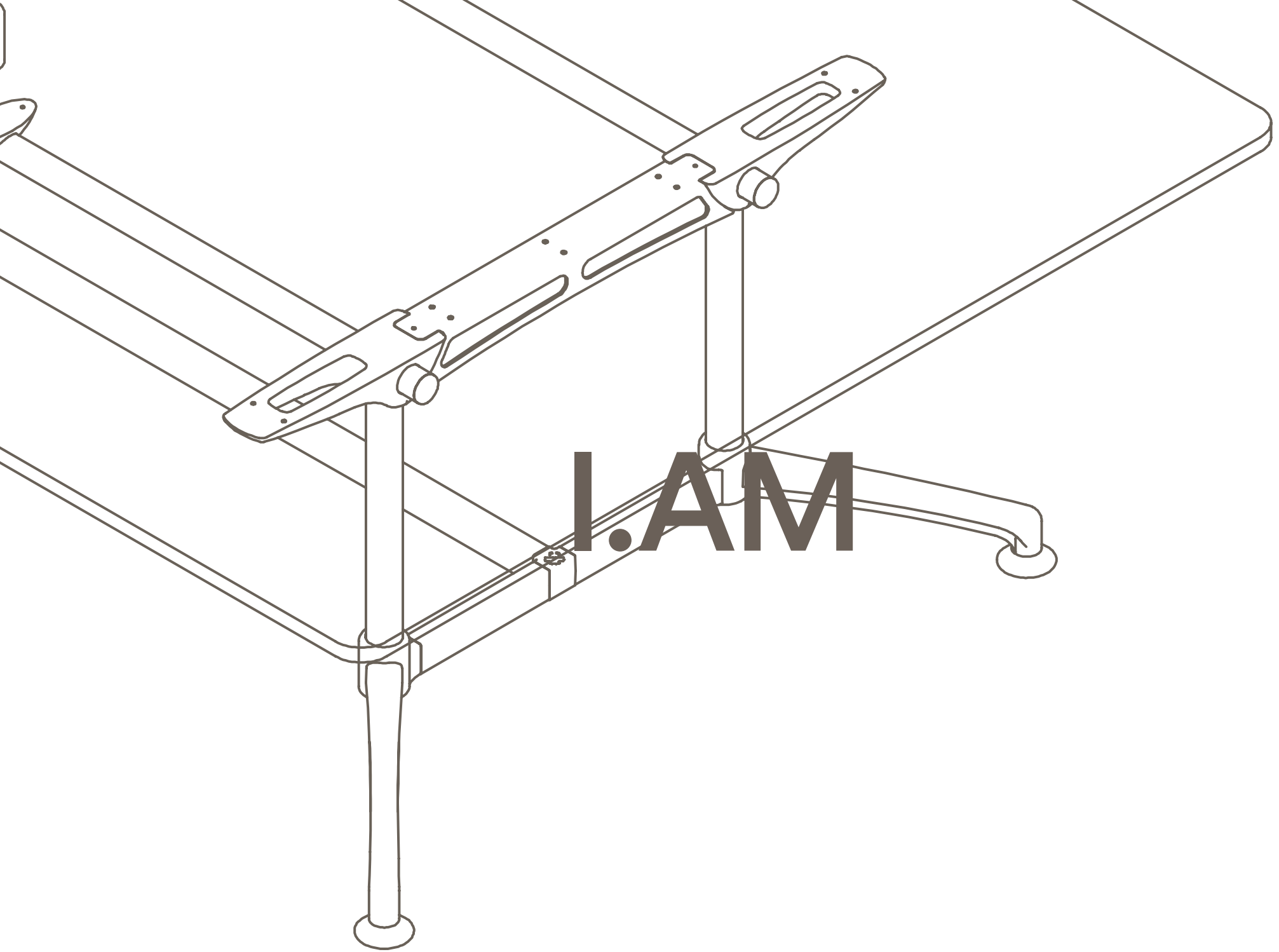

I.A.M.

Multi-Leg Finishes

1. Frame Finishes

Standard I.AM frame finishes include black or chrome legs with a polished foot. I.AM is also available in our current season powdercoat colours listed, with custom colour optional.

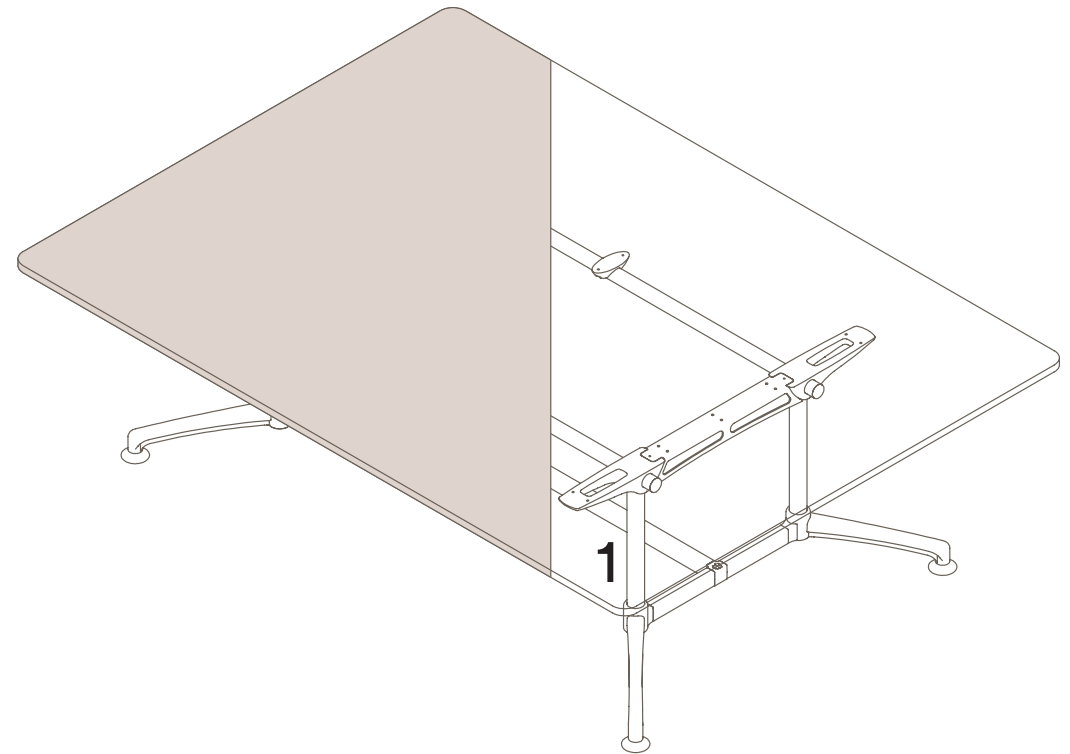
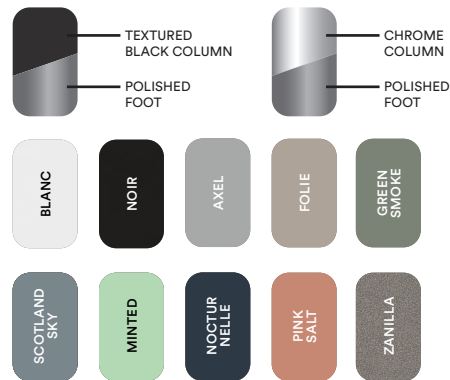

Colours are representative only, please check with your Thinking Works consultant to view samples of any specific colour.

Tables

Round / Square

Materials Information

Leg Finish

Steel Leg Column

- a. Textured Black (standard)
- b. Chrome (standard)
- c. Blanc
- d. Noir
- e. Axel
- f. Folie
- g. Green Smoke
- h. Scotland Sky
- i. Minted
- j. Nocturnelle
- k. Pink Salt
- l. Zanita

I-1020

720 (standard Height)

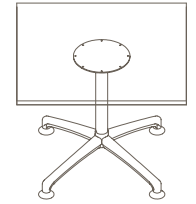
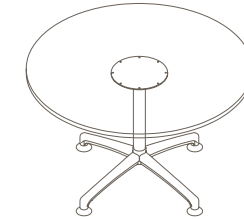
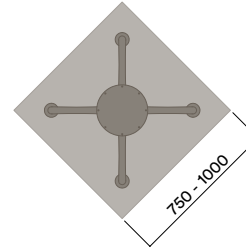
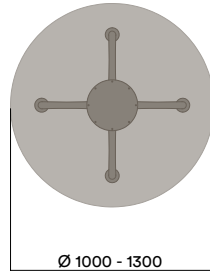

Foot Finish

Aluminium Foot

- a. Polished (standard)
- b. Powdercoat (to match column)

Frame Finish

Steel Top Horn

- a. Black Powdercoat

I-1021 Castors

720 (standard Height)

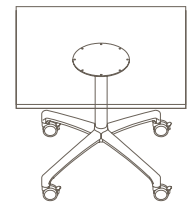
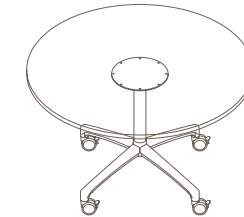
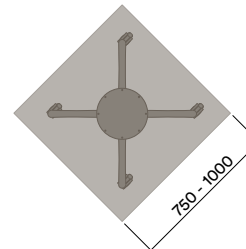
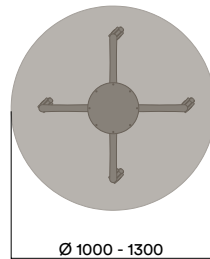

- * Maximum Custom Height 1000mm on Glides
900mm on Castors
- Maximum inc. worktop 40kg
- Maximum Point Load 50kg
- Seats 4

sydney office furniture

www.sydneyofficefurniture.com.au

Tables

Round / Square

Materials Information

Leg Finish

Steel Leg Column

- a. Textured Black (standard)
- b. Chrome (standard)
- c. Blanc
- d. Noir
- e. Axel
- f. Folie
- g. Green Smoke
- h. Scotland Sky
- i. Minted
- j. Nocturnelle
- k. Pink Salt
- l. Zanita

I-1025 Folding

720 (standard Height)

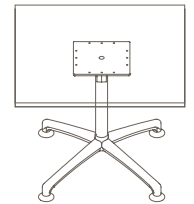
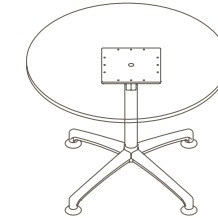
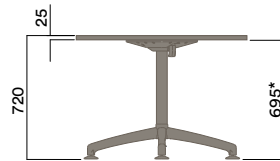
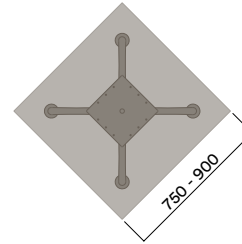
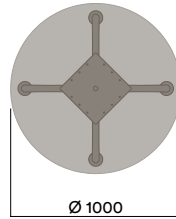

Foot Finish

Aluminium Foot

- a. Polished (standard)
- b. Powdercoat (to match column)

I-1026 Folding on Castors

720 (standard Height)

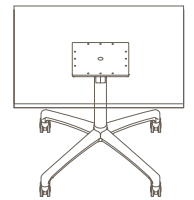
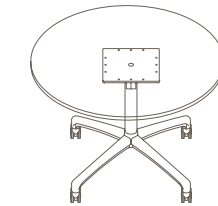
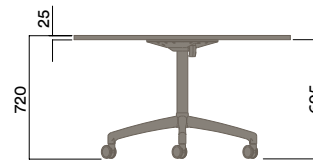
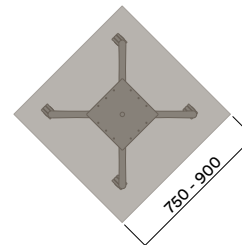
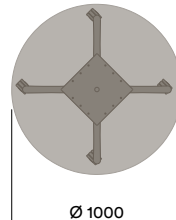

* Maximum Custom Height 1000mm on Glides
900mm on Castors
Maximum inc. worktop 40kg
Maximum Point Load 50kg
Seats 4

Tables

Round / Square

Materials Information

Leg Finish

Steel Leg Column

- a. Textured Black (standard)
- b. Chrome (standard)
- c. Blanc
- d. Noir
- e. Axel
- f. Folie
- g. Green Smoke
- h. Scotland Sky
- i. Minted
- j. Nocturnelle
- k. Pink Salt
- l. Zanilla

I-1030

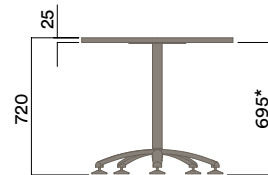
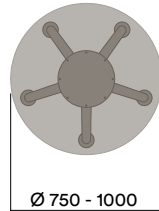

720 (standard Height)

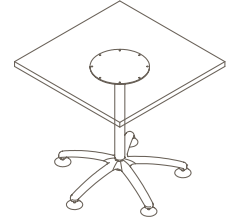
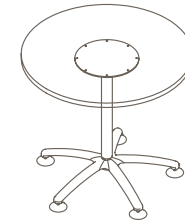
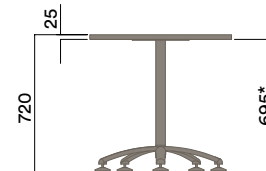
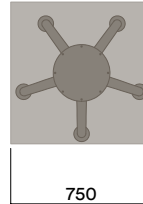

Foot Finish

Aluminium Foot

- a. Polished (standard)
- b. Powdercoat (to match column)

Frame Finish

Steel Top Horn

- a. Black Powdercoat

I-1031 Castors

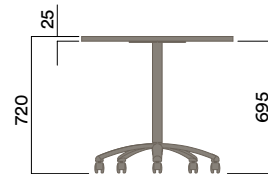
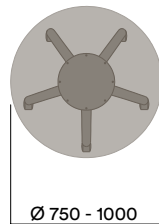

720 (standard Height)

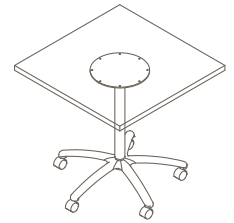
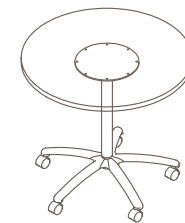
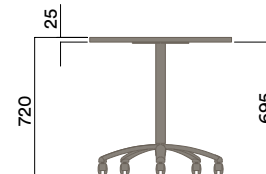
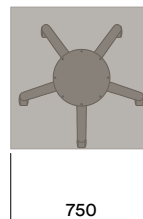

* Maximum Custom Height 695mm
 Maximum inc. worktop 20kg
 Maximum Point Load 30kg
 Seats 4

Tables

Round / Square

Materials Information

Leg Finish

Steel Leg Column

- a. Textured Black (standard)
- b. Chrome (standard)
- c. Blanc
- d. Noir
- e. Axel
- f. Folie
- g. Green Smoke
- h. Scotland Sky
- i. Minted
- j. Nocturnelle
- k. Pink Salt
- l. Zanilla

I-1032 Castors

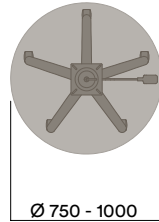

Gas Lift Height Adjustable

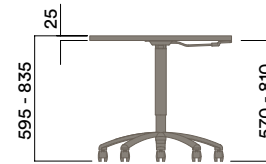
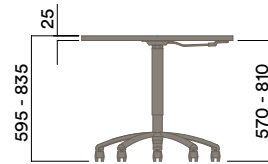
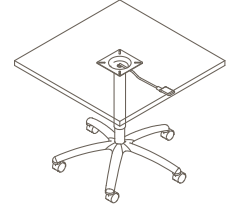
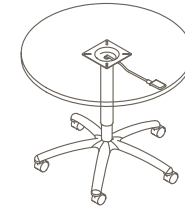
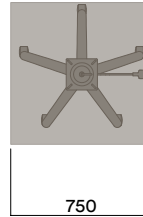

Foot Finish

Aluminium Foot

- a. Polished (standard)
- b. Powdercoat (to match column)

Frame Finish

Steel Top Horn

- a. Black Powdercoat

I-1033

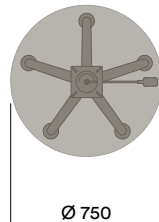

Gas Lift Height Adjustable

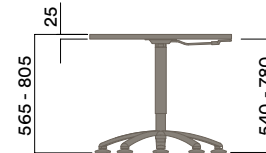
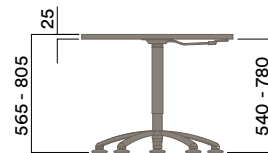
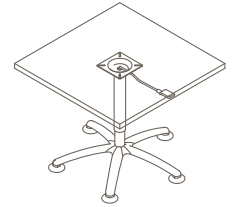
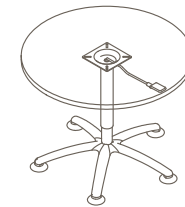
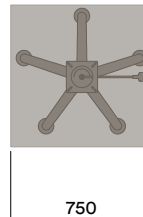

Maximum inc. worktop 20kg
 Maximum Point Load 30kg
 Seats 4

 sydney office furniture

Tables

Round / Square

Materials Information

Leg Finish

Steel Leg Column

- a. Textured Black (standard)
- b. Chrome (standard)
- c. Blanc
- d. Noir
- e. Axel
- f. Folie
- g. Green Smoke
- h. Scotland Sky
- i. Minted
- j. Nocturnelle
- k. Pink Salt
- l. Zanilla

I-1035 Folding

720 (standard Height)

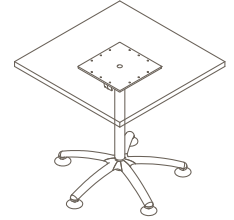
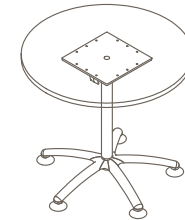
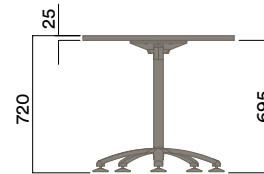
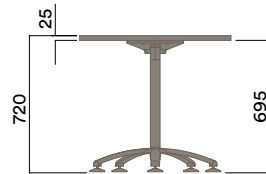
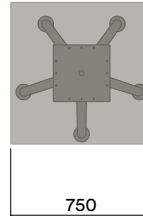
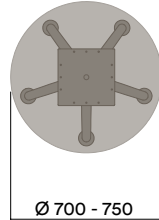

Foot Finish

Aluminium Foot

- a. Polished (standard)
- b. Powdercoat (to match column)

I-1036 Folding on Castors

720 (standard Height)

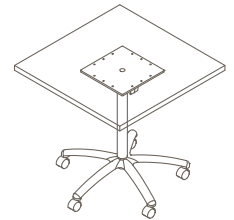
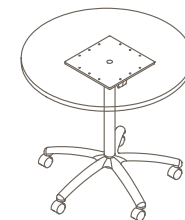
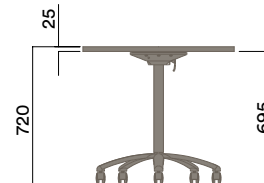
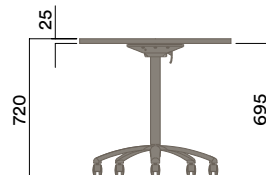
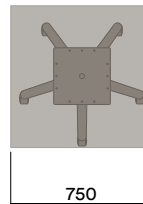
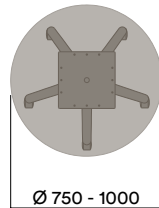

Maximum inc. worktop 20kg
 Maximum Point Load 30kg
 Seats 4

 sydney office furniture

www.sydneyofficefurniture.com.au

Tables

Rectangle

Materials Information

Leg Finish

Steel Leg Column

- a. Textured Black (standard)
- b. Chrome (standard)
- c. Blanc
- d. Noir
- e. Axel
- f. Folie
- g. Green Smoke
- h. Scotland Sky
- i. Minted
- j. Nocturnelle
- k. Pink Salt
- l. Zanilla

I-1000, I-1001, I-1002

720 (standard Height)

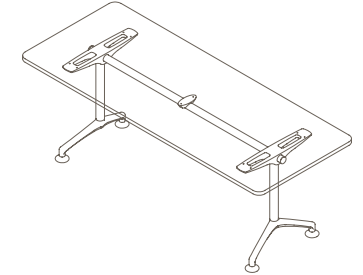
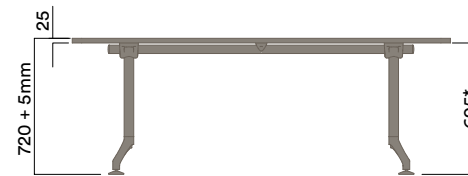
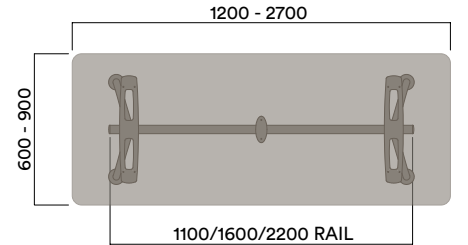

Foot Finish

Aluminium Foot

- a. Polished (standard)
- b. Powdercoat (to match column)

Frame Finish

Polished Aluminium Top Horn
Steel Black Powdercoat Rails

I-1010, I-1011, I-1012

720 (standard Height)

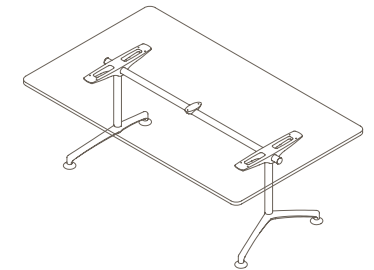
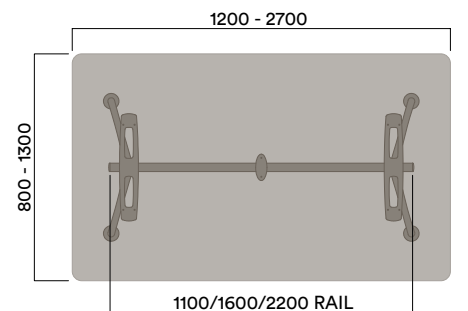

- * Maximum Custom Height 1000mm on Glides
900mm on Castors
- Maximum inc. worktop 100kg
- Maximum Point Load 50kg
- Seats 4-6

sydney office furniture

Tables

Rectangle

Materials Information

Leg Finish

Steel Leg Column

- a. Textured Black (standard)
- b. Chrome (standard)
- c. Blanc
- d. Noir
- e. Axel
- f. Folie
- g. Green Smoke
- h. Scotland Sky
- i. Minted
- j. Nocturnelle
- k. Pink Salt
- l. Zanita

Foot Finish

Aluminium Foot

- a. Polished (standard)
- b. Powdercoat (to match column)

Frame Finish

Polished Aluminium Top Horn
Steel Black Powdercoat Rails

I-1040

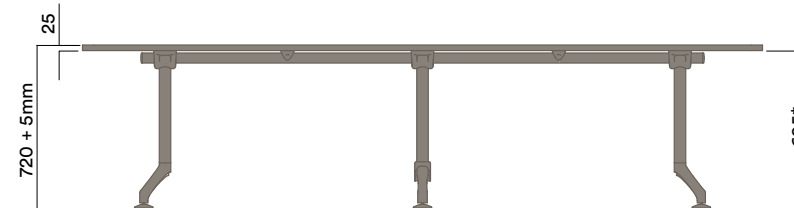
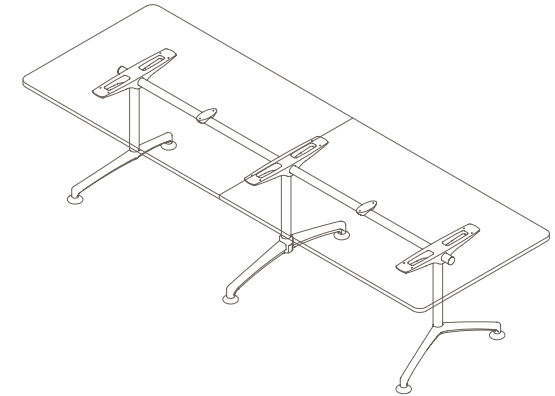
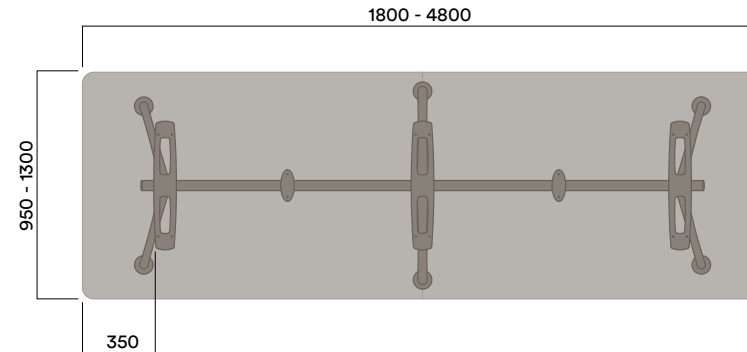

I-1041

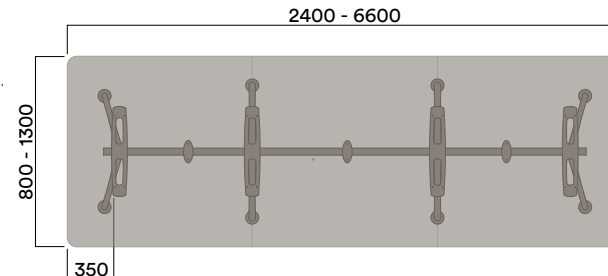

* Maximum Custom Height	1000mm
Maximum inc. worktop	130kg
Maximum Point Load	50kg
Seats	6-18

sydney office furniture

Tables Boatshape

Materials Information

Leg Finish

Steel Leg Column

- a. Textured Black (standard)
- b. Chrome (standard)
- c. Blanc
- d. Noir
- e. Axel
- f. Folie
- g. Green Smoke
- h. Scotland Sky
- i. Minted
- j. Nocturnelle
- k. Pink Salt
- l. Zanilla

Foot Finish

Aluminium Foot

- a. Polished (standard)
- b. Powdercoat (to match column)

Frame Finish

Polished Aluminium Top Horn
Steel Black Powdercoat Rails

I-1044

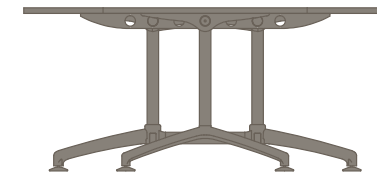
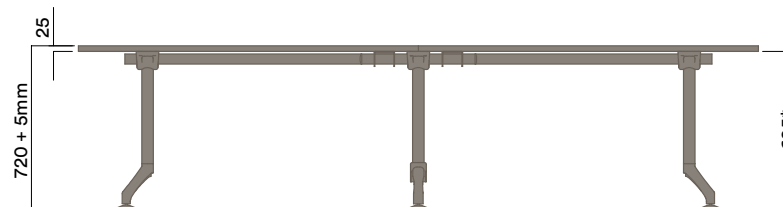
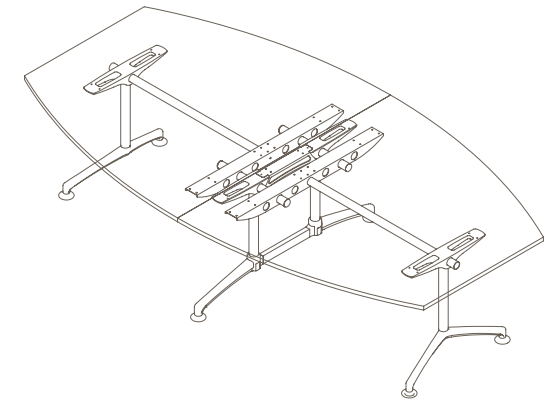
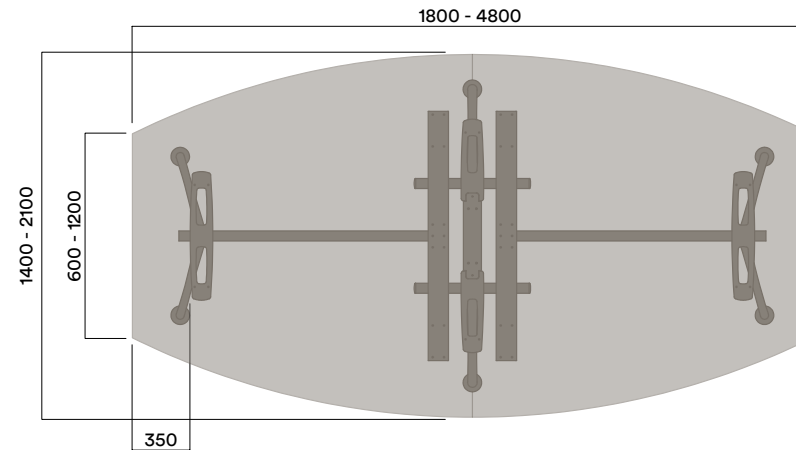

I-1046

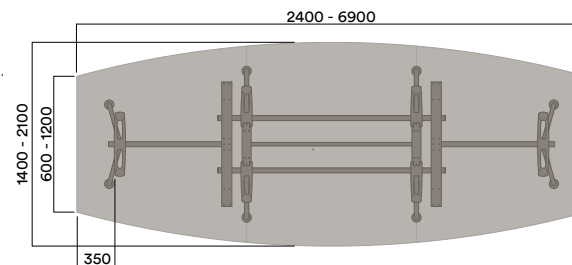

* Maximum Custom Height 1000mm
Maximum inc. worktop 160kg
Maximum Point Load 50kg
Seats 6-18

sydney office furniture

Multi-Leg Round/Square

Materials Information

I-1070

Leg Finish

Steel Leg Column and Lower Frame

- a. Textured Black (standard)
- b. Chrome (standard)
- c. Blanc
- d. Noir
- e. Axel
- f. Folie
- g. Green Smoke
- h. Scotland Sky
- i. Minted
- j. Nocturnelle
- k. Pink Salt
- l. Zanilla

Foot Finish

Aluminium Foot

- a. Polished - Standard
- b. Powdercoat - to match frame

Frame Finish

Polished Aluminium Top Horn

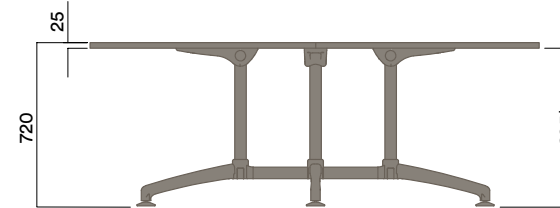
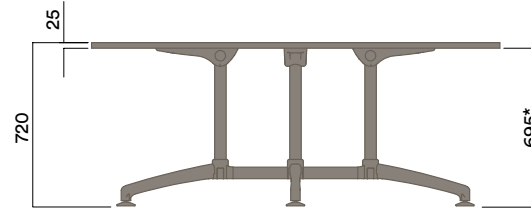
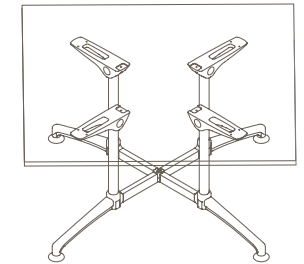
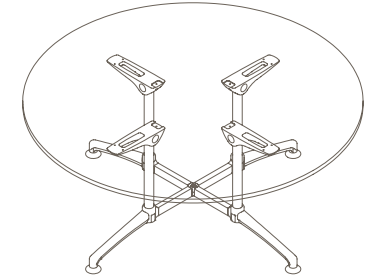
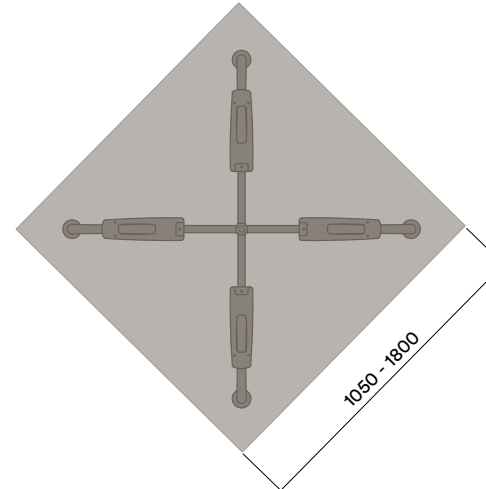
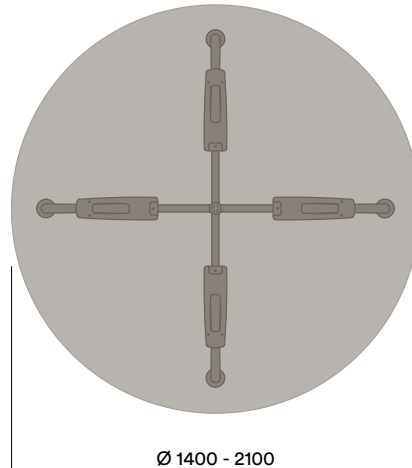

* Maximum Custom Height	1000mm
Maximum inc. worktop	80kg
Maximum Point Load	50kg
Seats	4-6

sydney office furniture

Multi-Leg Rectangle

Materials Information

Leg Finish

Steel Leg Column

- a. Textured Black (standard)
- b. Chrome (standard)
- c. Blanc
- d. Noir
- e. Axel
- f. Folie
- g. Green Smoke
- h. Scotland Sky
- i. Minted
- j. Nocturnelle
- k. Pink Salt
- l. Zanilla

Foot Finish

Aluminium Foot

- a. Polished (standard)
- b. Powdercoat (to match column)

Frame Finish

Polished Aluminium Top Horn
Steel Black Powdercoat Rails

I-1050 4 Leg

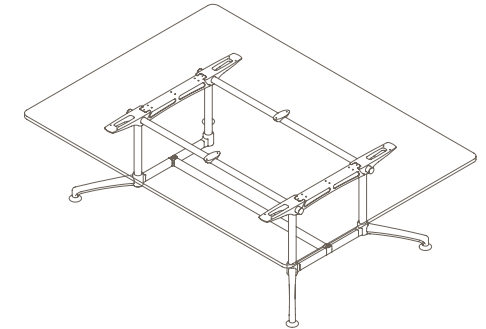
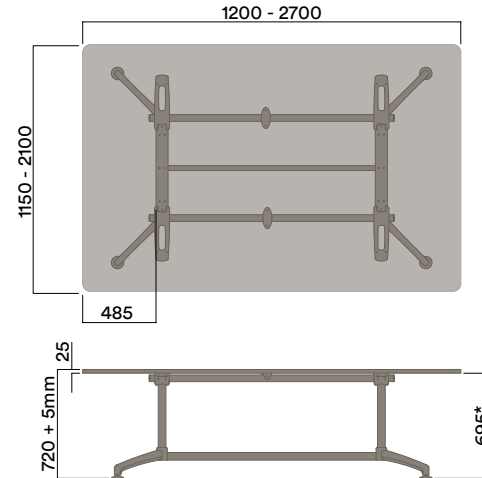

I-1051 6 Leg

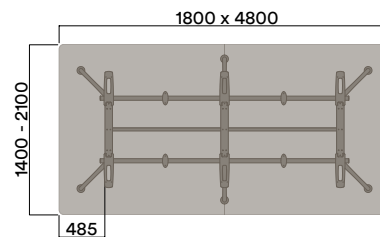

I-1052 8 Leg

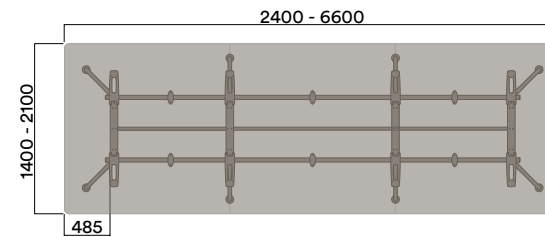

I-1053 10 Leg

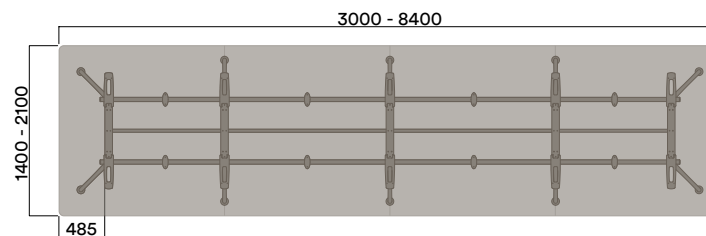

* Maximum Custom Height	1000mm
Maximum inc. worktop	160kg
Maximum Point Load	50kg
Seats	4-24

sydney office furniture

www.sydneyofficefurniture.com.au

Tables Folding

Materials Information

I-1080 , I-1082, I-1084, I-1086 720 (standard Height)

Leg Finish

Steel Leg Column

- a. Textured Black (standard)
- b. Chrome (standard)
- c. Blanc
- d. Noir
- e. Axel
- f. Folie
- g. Green Smoke
- h. Scotland Sky
- i. Minted
- j. Nocturnelle
- k. Pink Salt
- l. Zanilla

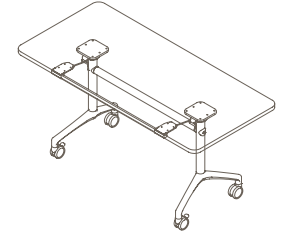
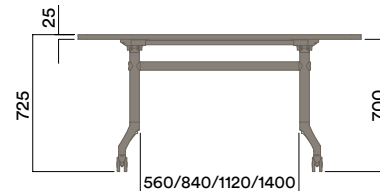
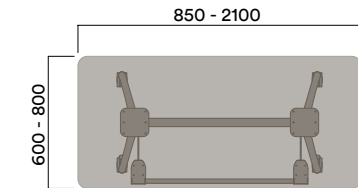

Foot Finish

Aluminium Foot

I-1081, I-1083, I-1085, I-1087 720 (standard Height)

- a. Polished (standard)
- b. Powdercoat (to match column)

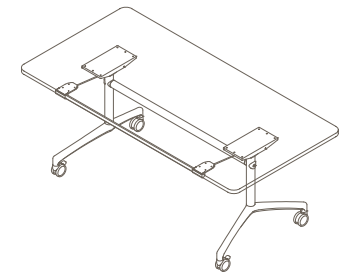
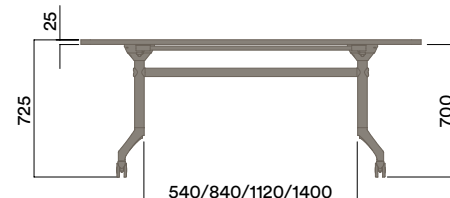
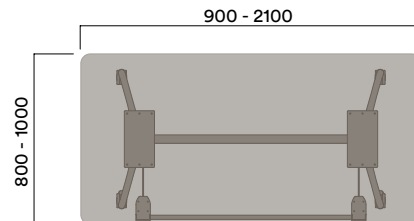

* Maximum Custom Height 1000mm on Glides
900mm on Castors
Maximum inc. worktop 24kg
Maximum Point Load 30kg
Seats 4-6

sydney office furniture

Tables Features

Materials Information

Frame Finish

Steel Slingshot

a. Powdercoat (to match frame)

Steel Power/Data Beam

a. Black Powdercoat

Powerbox Management

Slingshot

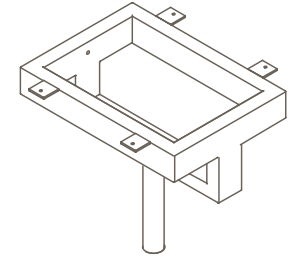
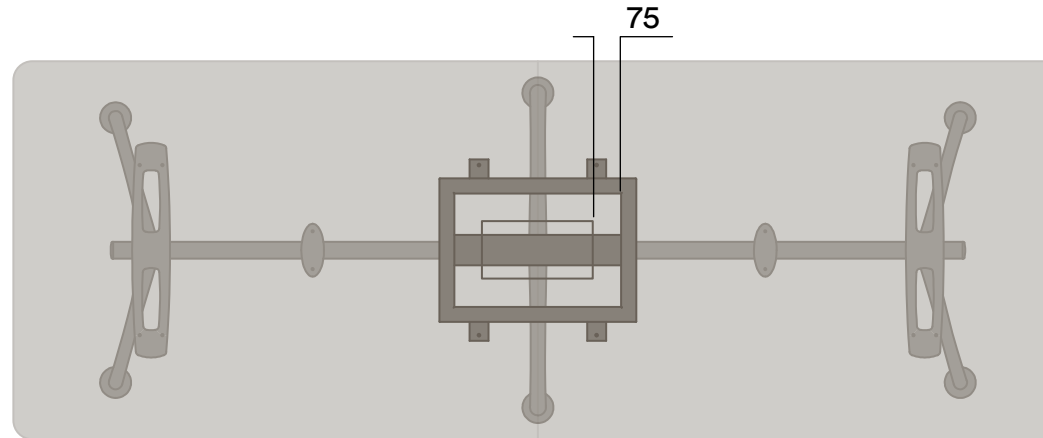

Powerbox Slingshot

Suitable for I-1040 and I-1041 table frames

Replaces I.AM leg column to provide placement of powerboxes without frame interference

Made to order to cater for specified powerbox requirements and size

Provides 75mm clearance around powerbox to ensure fitment without frame interference

Power/Data Beam

Suitable for I-1000, I-1001 and I-1002 frames

Suitable for I-1010, I-1011 and I-1012 frames

Replaces central rail to provide placement of powerboxes without frame interference

Made to order to cater for specified powerbox requirements and size

Provides 50mm clearance around powerbox to ensure fitment without frame interference

Powerbox Management

Power/Data Beam

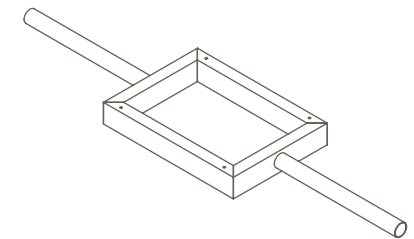
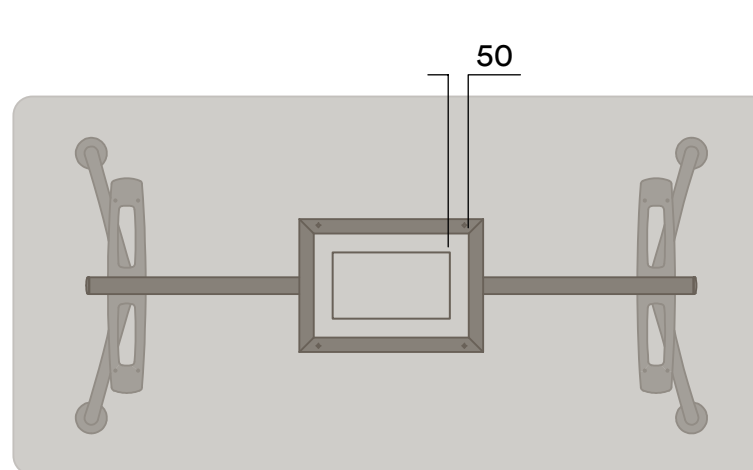

sydney office furniture

Tables Features

Materials Information

Frame Finish

Steel Multi-Leg Spacer

a. Black Powdercoat

Steel Outrigger

a. Black Powdercoat

Powerbox Management

Multi-Leg Spacers

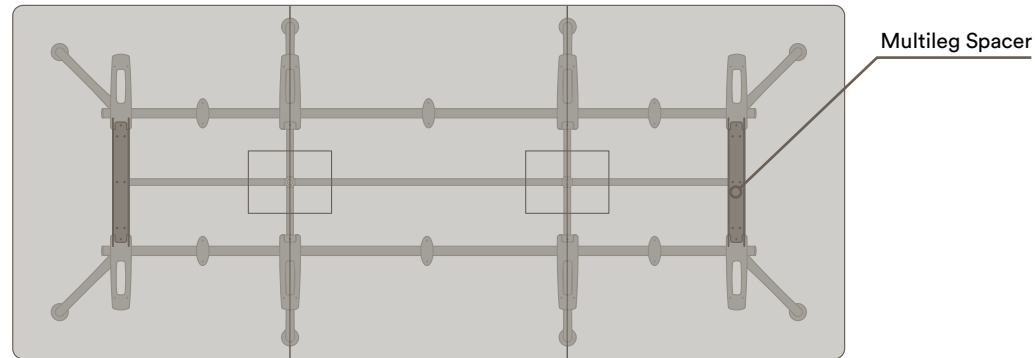

Worktop Management

Outriggers

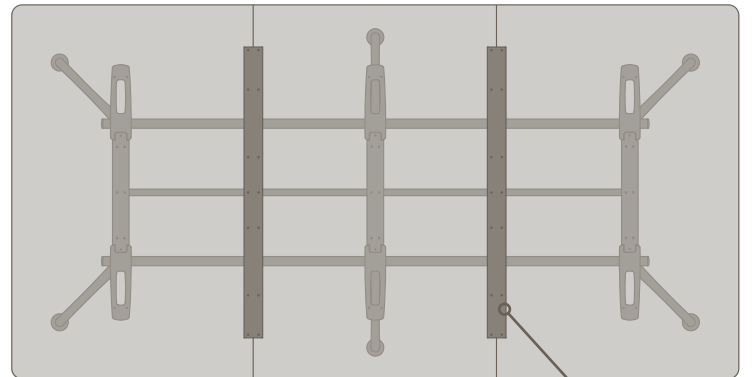

Multi-leg Spacers

Provided with frame, spacers can be removed on-site to provide placement of powerboxes without frame interference

Applies to all Multi-Leg Rectangle Frames

Outriggers

Additional Outriggers can be purchased to provide adequate worktop support on odd worktop splits

Outriggers available to suit SML, MED and LRG width Multi-Leg frames

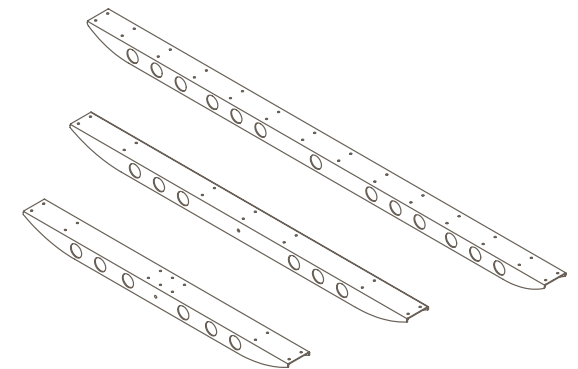

 **sof**
sydney office furniture



Specification

If you would like a sample set of any of our finishes, please call us on 61 (0)2 9726 7177 or e-mail at sales@thinkingw.com.

Due to our policy of continuous product development, specifications and finishes may change without prior notice.

Sustainability Policy

We realise the importance of responsible business practices and have in place numerous product and company sustainability certifications. We would encourage you to download our annual Sustainability Report from the Thinking Works website to get a full overview of our sustainability program.

Thinking Works
© Copyright 2020
All right reserved

Thinking Works
25 Helles Avenue
Moorebank
New South Wales 2170

www.thinkingw.com
61 (0)2 9726 7177
sales@thinkingw.com